

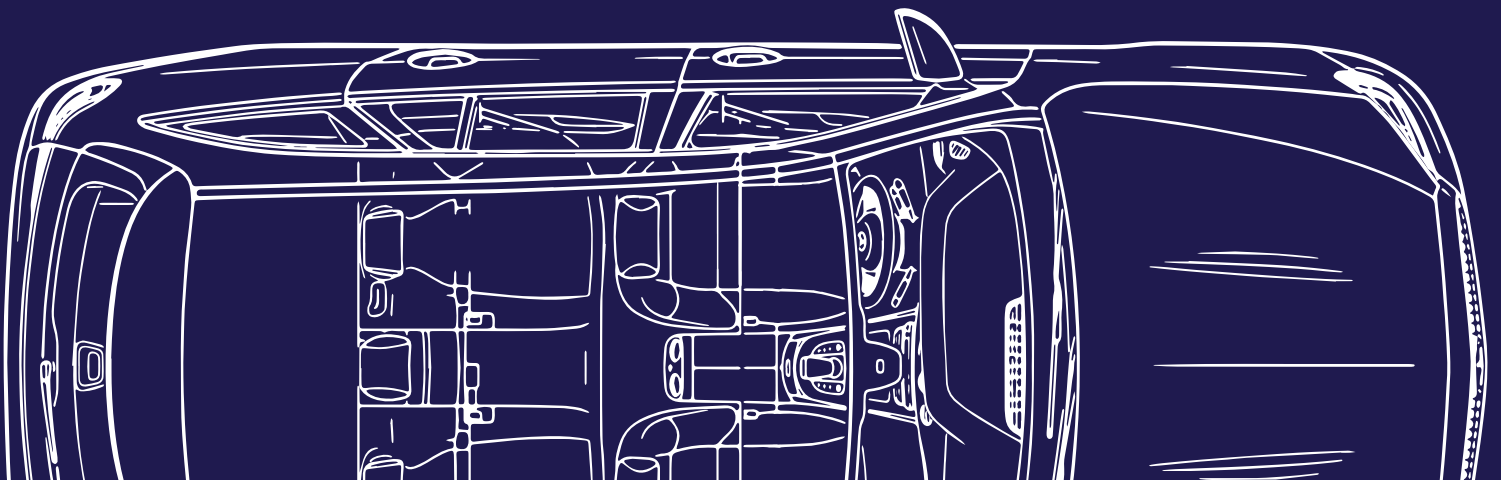

ACO BATTERY

Ashja Battery Manufacturing and Trading Group

TINO
CALCIUM SMF BATTERY





ACO BATTERY

Ashja Battery Manufacturing and Trading Group

We are committed

Since: 1982

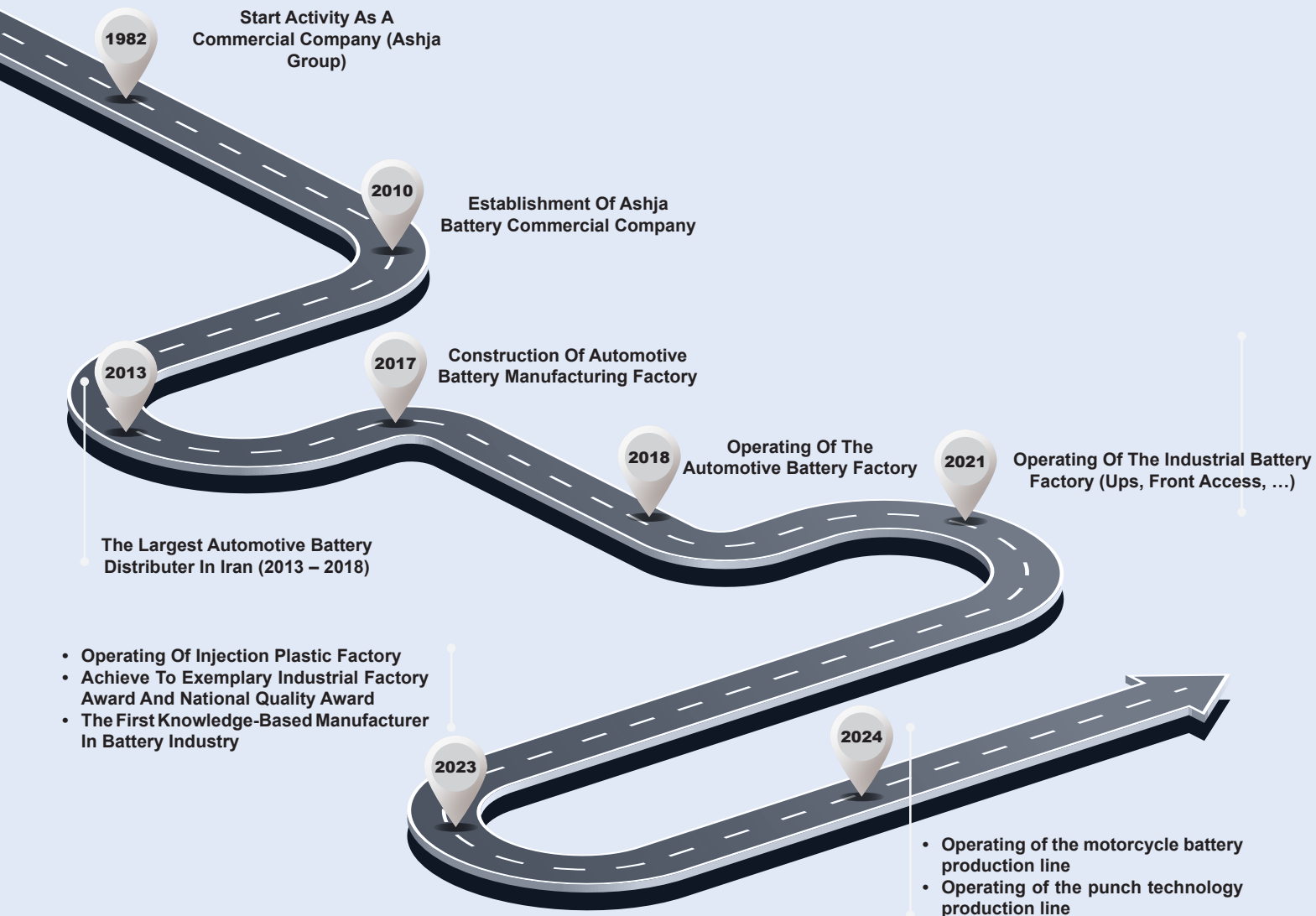



ACO battery industrial group, with more than 40 years brilliant experiences in battery industry, has started activity since 1982 as a commercial company and then as an agent of Iranian battery manufacturer in all regions of Iran.

The activity of this group continued until 2010, and in this year has established the ASHJA commercial company. Since this year, the extensive activity in battery distribution led to recognition as an agent with exclusive brand of the domestic and foreign battery manufacturer. As well, with considering to decrease in battery supply, attended direction corporation with the foreign battery manufacturer from Turkey, Ukraine and Korea and under the exclusive brand.

ACO battery's extensive activity since 2013 included all of regions in Iran, and ACO's agents and wholesalers in all of regions started to distribution of batteries. This ACO battery's strategy, caused to become the largest battery distributor in Iran since 2013 to 2018.

Since 2017, considering to national requirements and international conditions, construction of automotive battery manufacturing factory was performed after scientific and technical reviews, and in 2018, operation of automotive battery manufacturer was done.

In the first phase, production of plates with expanded metal technology tested successfully and started operational production. In the second phase since 2019, operated all of the levels of production chain include recycling, plates creation, assembling and battery charging. As well since 2023, battery covers and top covers has created in TINOO PLAST factory that is related to ACO battery industrial group.

At the moment, variety of Amps in the ACO battery, include 35 to 225 A/h and under the TINOO, CARPILE, HIPILE brands, and other new brand that released recently is HANDEL that equipped with the new technology and technical design with 21 months guarantee. Our slogan is 'we are committed' and according with this slogan, following international standards in both technical and production point is our main responsibility.

Since 2020, accordance with the investigations on industrial battery market and due to the research by ACO battery's R&D sector, and utilization of the advanced technology in the world, ACO battery started to manufacture of UPS batteries under ZICO and UFO brands, and in 2023, recognized as the first knowledge-based manufacturer in battery industry in Iran. As well, access to exemplary industrial factory award and national quality award as other ACO battery's achievements.

According to planning and consider to domestic market requirements, started pre-product of motorcycle battery under the HANDEL brand and variety Amps, and in 2024, mass production will be done. In near future recycling factory, automotive battery factory, lithium-ion and UPS factory and plastic injection factory will separate.

TiNOO

CALCIUM SMF BATTERY

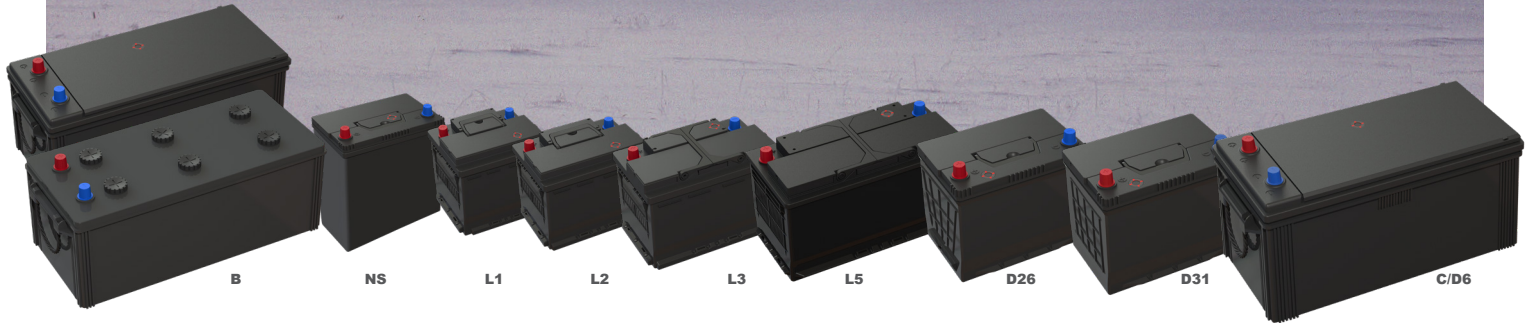

Battery Base Hold Down (Dimension in millimetre)

B00	NS-B-C/D6			
B13	L1-L2-L3			
B16	L5			
B09	D26			
B01	D31			

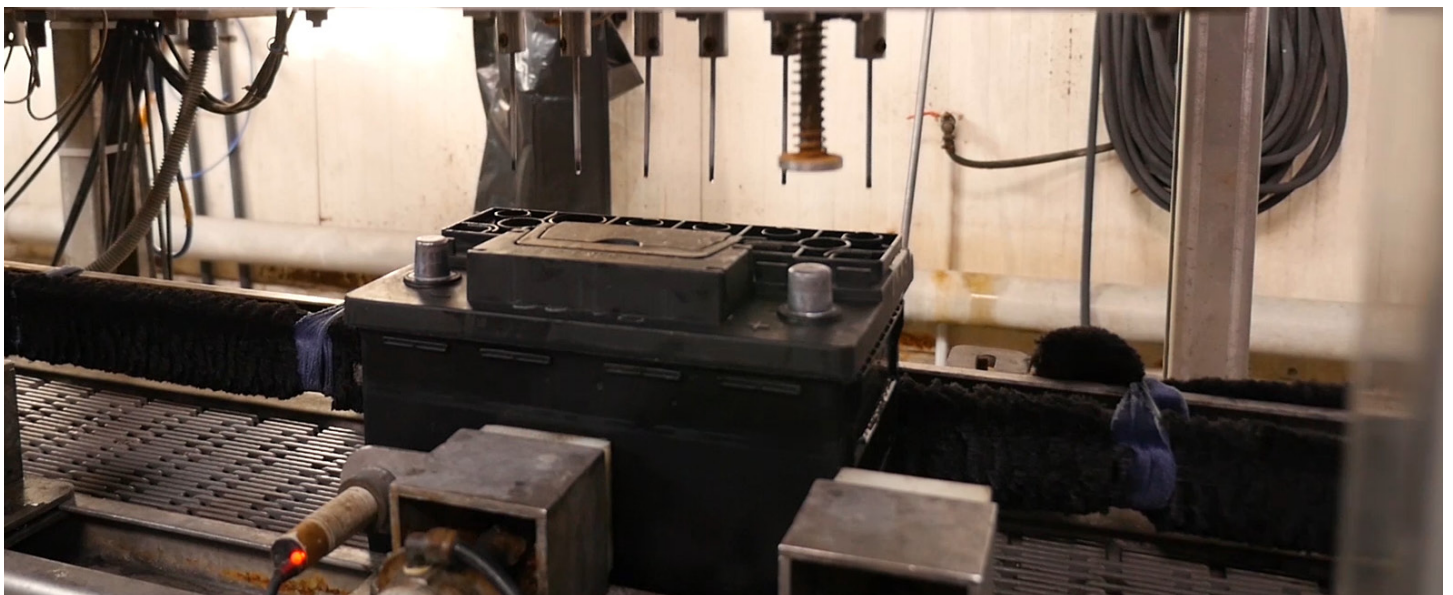
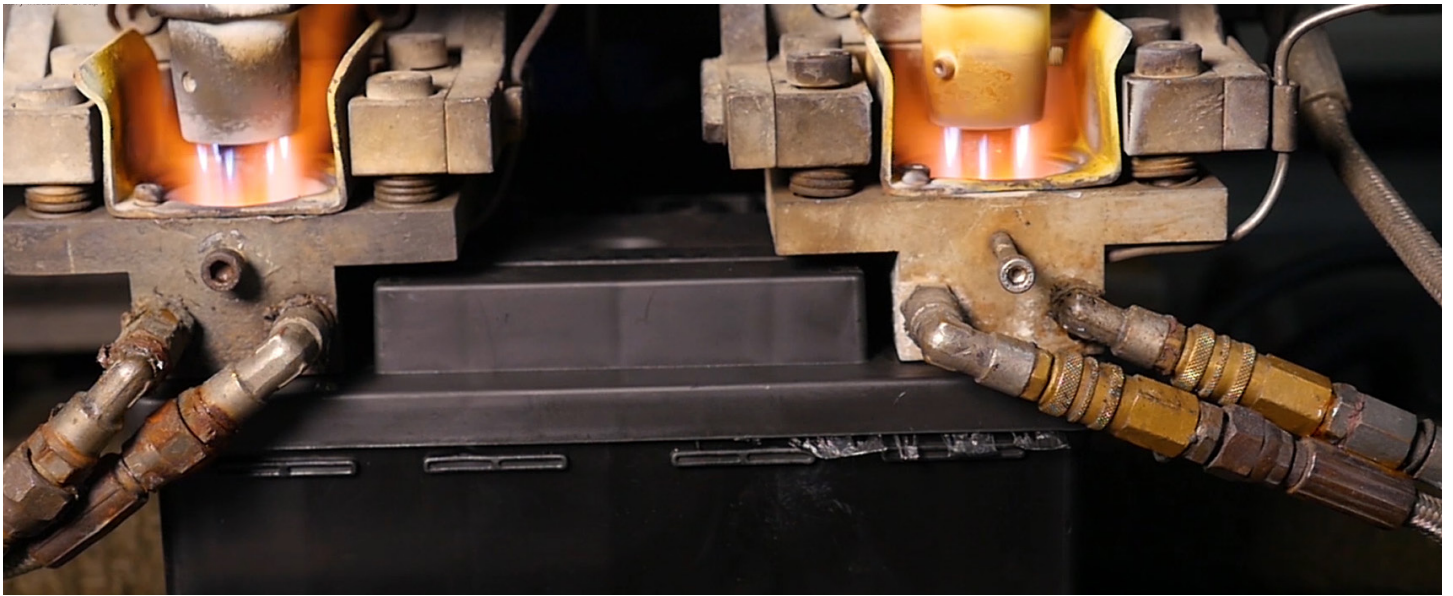

Terminal Layout

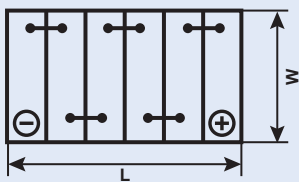

Layout 0

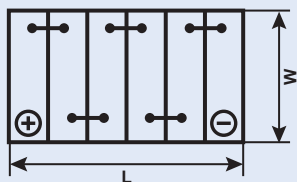

Layout 1

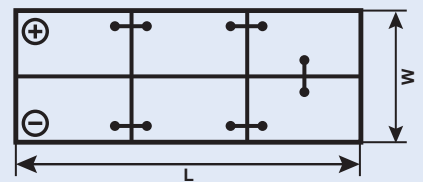





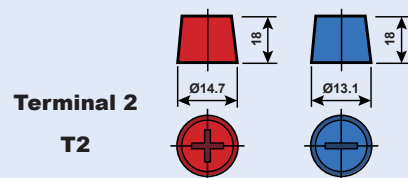
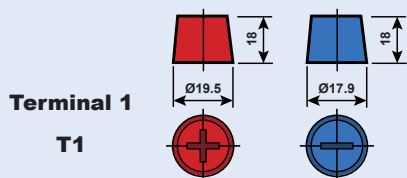













Layout 2

Terminal Type (Dimension in millimetre)





SERI 1	Type	Model	Sealed/ Non-Sealed	Capacity 20HR (Ah, 25°C)	CCA ISIRI/EN (A, -18 °C)	Terminal Type	Terminal Layout	Hold Down	Overall Dimension (mm)				Weight (±3%Kg)
									Length	Width	Height	T.Height	
	L1	SMF55040	Sealed	50	350	T1	0	B13	206	175	188	188	12.60
	L2	SMF55010	Sealed	50	420	T1	0	B13	240	175	188	188	13.60
	L2	SMF55510	Sealed	55	480	T1	0	B13	240	175	188	188	14.20
	L2	SMF56010	Sealed	60	350	T1	0	B13	240	175	188	188	14.80
	L3	SMF56610	Sealed	66	500	T1	0	B13	278	175	188	188	16.70
	L3	SMF57410	Sealed	74	540	T1	0	B13	278	175	188	188	17.30
	L5	SMF59010	Sealed	90	720	T1	0	B16	353	175	190	190	22.30
	L5	SMF60010	Sealed	100	740	T1	0	B16	353	175	190	190	23.50

SERI 2	Type	Model	Sealed/ Non-Sealed	Capacity 20HR (Ah, 25°C)	CCA ISIRI/EN (A, -18 °C)	Terminal Type	Terminal Layout	Hold Down	Overall Dimension (mm)				Weight (±3%Kg)
									Length	Width	Height	T.Height	
	D26	SMF605D26L	Sealed	60	480	T1	0	B09	265	175	198	220	16.30
	D26	SMF605D26R	Sealed	60	480	T1	1	B09	265	175	198	220	16.30
	D26	SMF705D26L	Sealed	70	500	T1	0	B09	265	175	198	220	17.60
	D26	SMF705D26R	Sealed	70	500	T1	1	B09	265	175	198	220	17.60
	B20 (NS40)	SMF351B20L	Sealed	35	320	T2	0	B00	196	126	204	227	10.90
	B20 (NS40)	SMF351B20R	Sealed	35	320	T2	1	B00	196	126	204	227	10.90
	B24 (NS60)	SMF451B24L	Sealed	45	380	T1	0	B00	237	126	204	227	12.85
	B24 (NS60)	SMF451B24R	Sealed	45	380	T1	1	B00	237	126	204	227	12.85
	D31	SMF901D31R	Sealed	90	640	T1	1	B00	306	175	202	225	22.20
	D31	SMF901D31L	Sealed	90	640	T1	0	B00	306	175	202	225	22.20



SERI 3	Type	Model	Sealed/ Non-Sealed	Capacity 20HR (Ah, 25°C)	CCA ISIRI/EN (A, -18 °C)	Terminal Type	Terminal Layout	Hold Down	Overall Dimension (mm)				Weight (±3%Kg)
									Length	Width	Height	T.Height	
	B	LM65010	Non-Sealed	150	900	T1	2	B00	513	222	192	215	40.20
	B	SMF65020	Sealed	150	900	T1	2	B00	513	222	202	223	40.20
	B	LM70010	Non-Sealed	200	1100	T1	2	B00	513	222	192	215	47.40
	B	SMF70020	Sealed	200	1100	T1	2	B00	513	222	202	223	47.40
	C/D6	SMF72520	Sealed	225	1150	T1	2	B00	508	265	222	244	55.80

We are committed



HSE-MS
ISO 14001:2015
ISO 45001:2018





ACO BATTERY

Ashja Battery Manufacturing and Trading Group

ACO BATTERY

CALCIUM SMF BATTERY CATALOGUE



aco-battery.com